

A

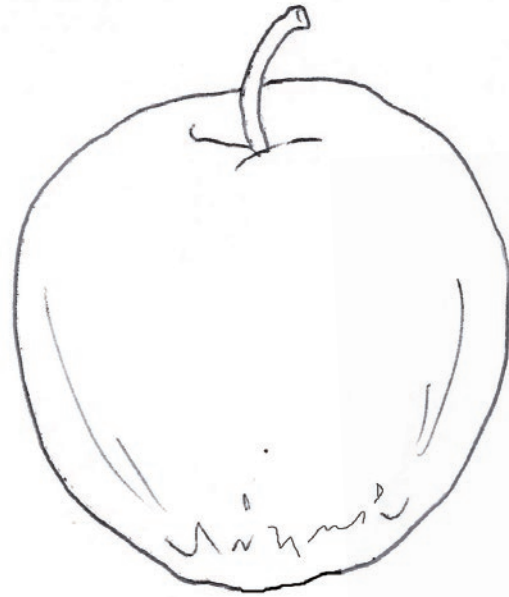

apple

a

ant

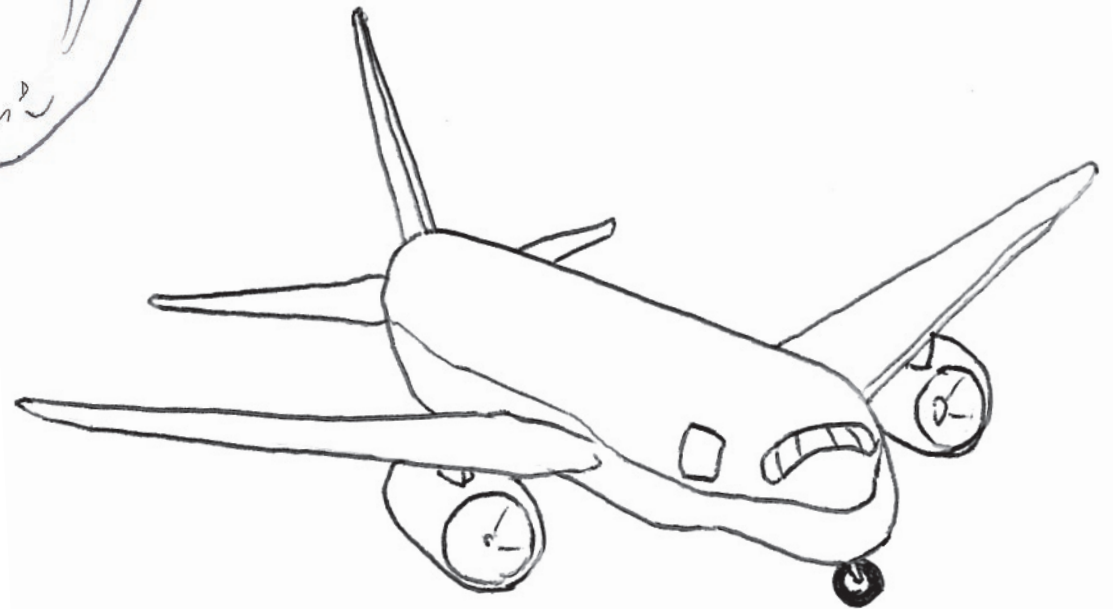

airplane

B

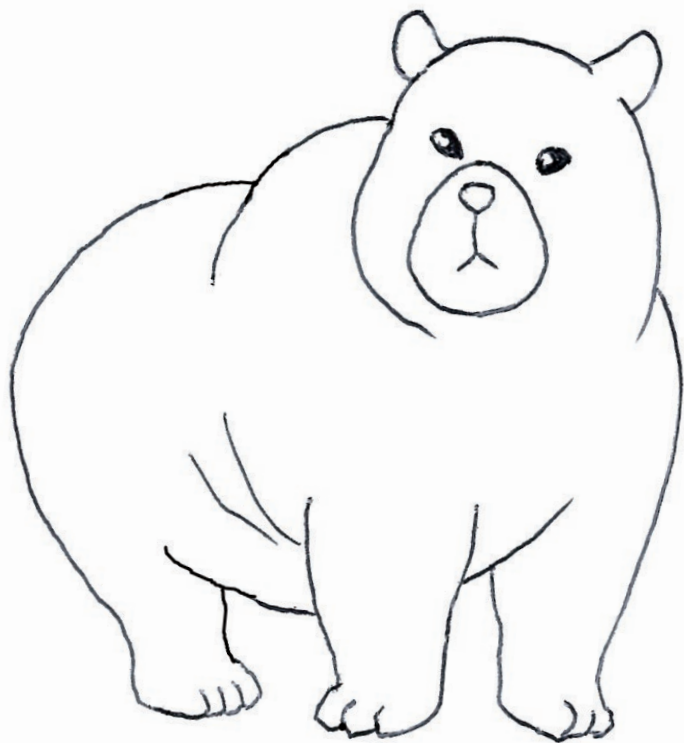

bear

b

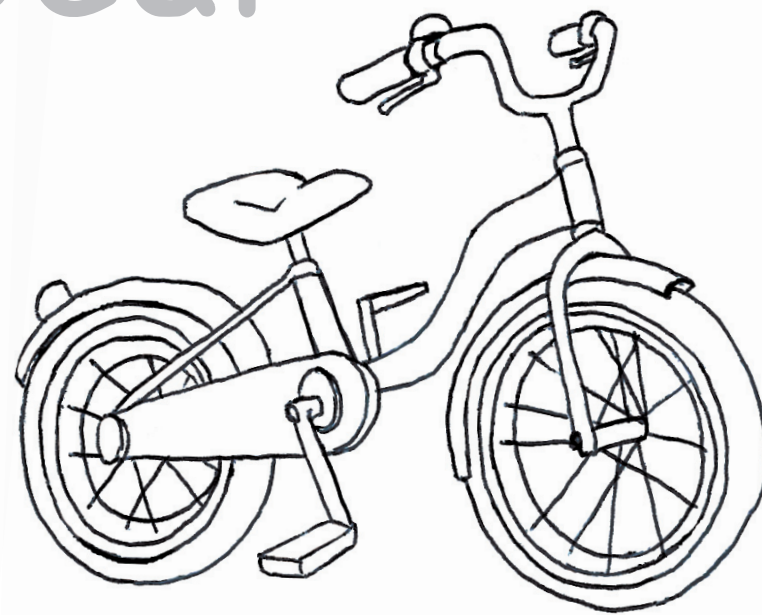

bicycle



beetle



butterfly

C

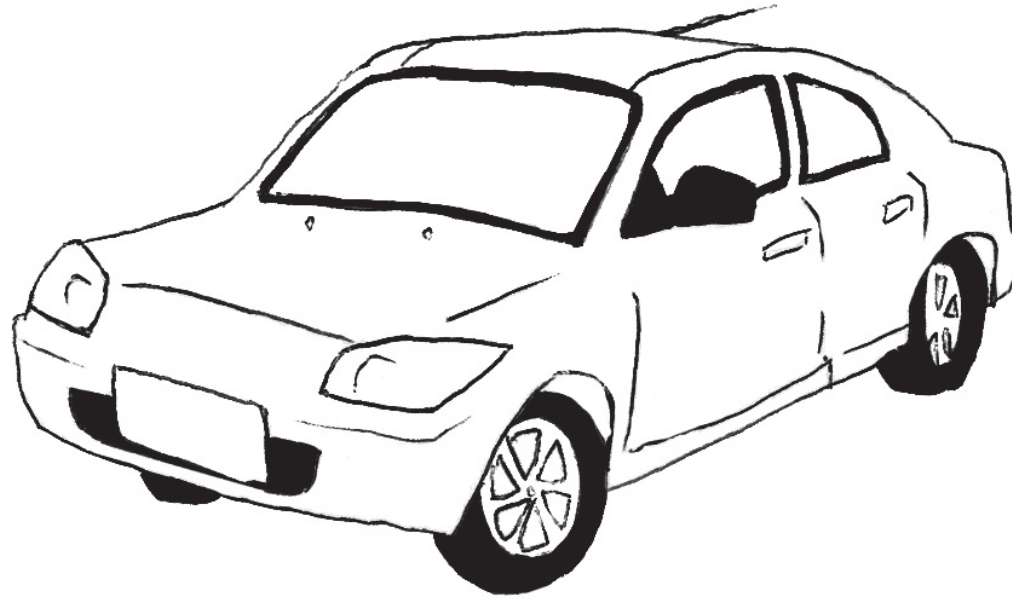

car

C

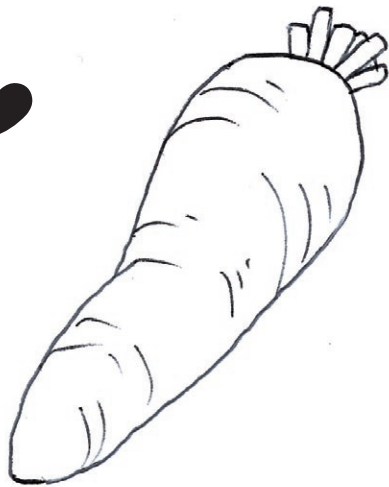

carrot

candy

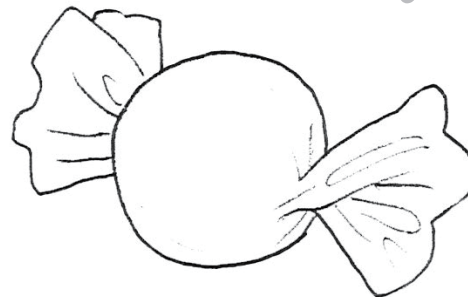

COW

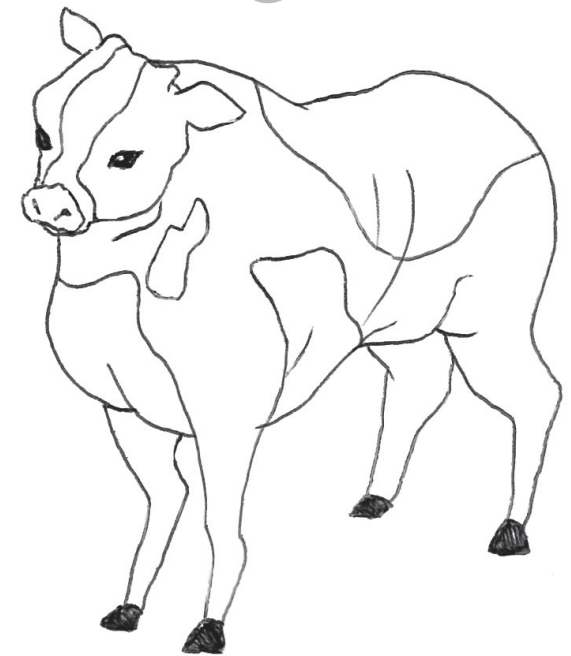

D

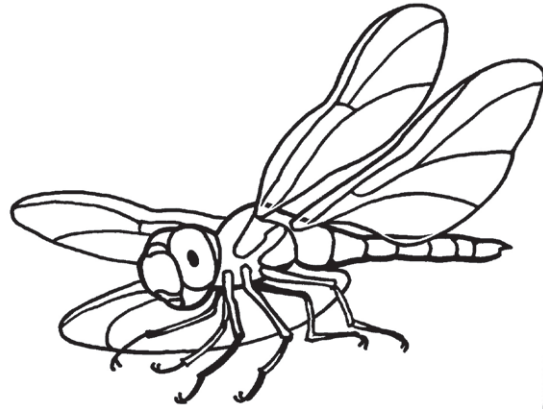

dragonfly

d

dog



dolphin

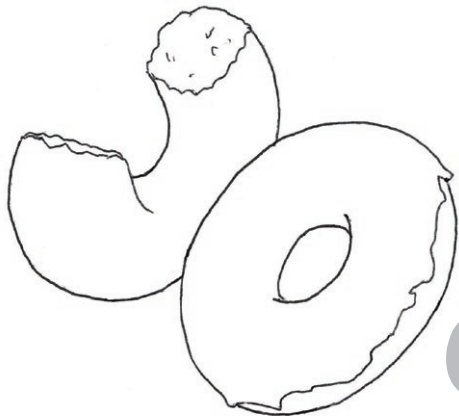

donuts

E

elephant

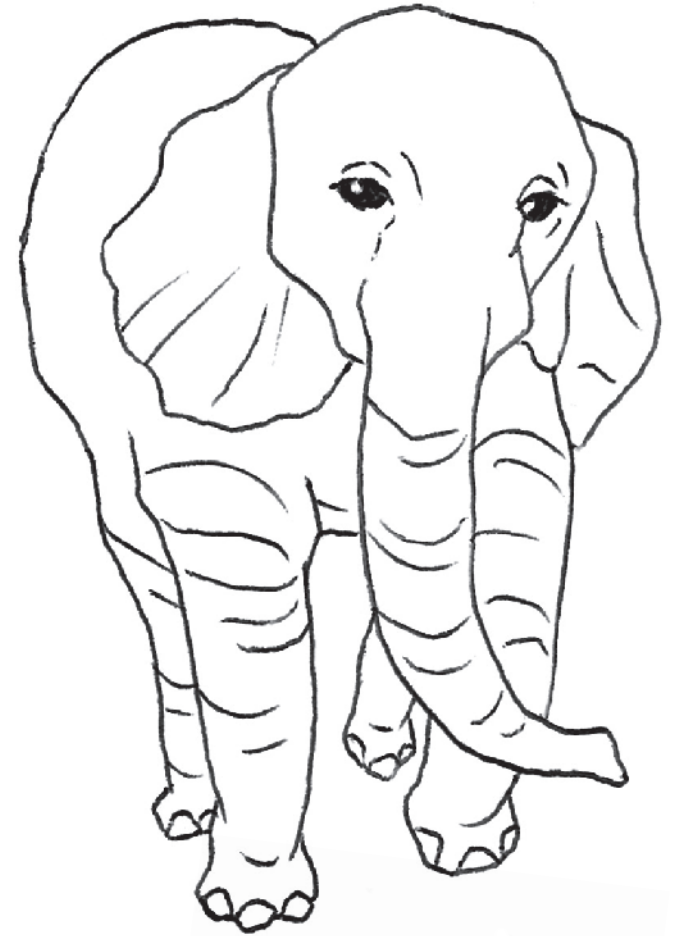

e

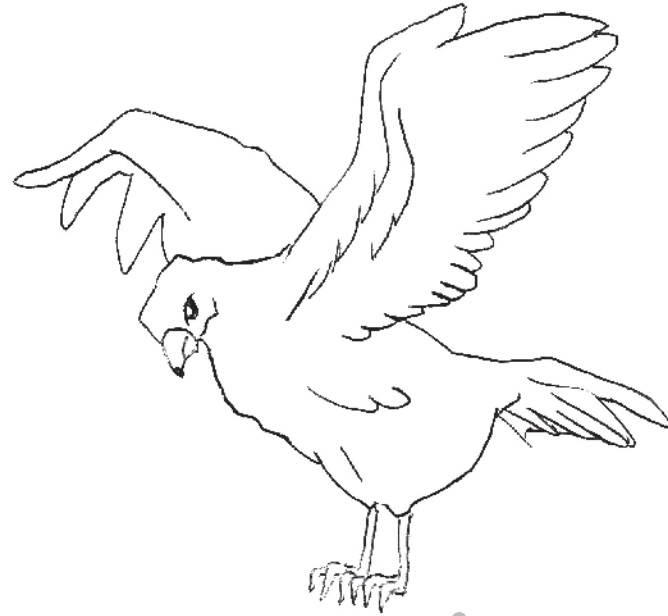

eagle

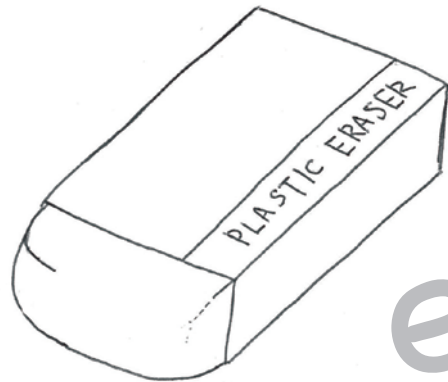

eraser

eye

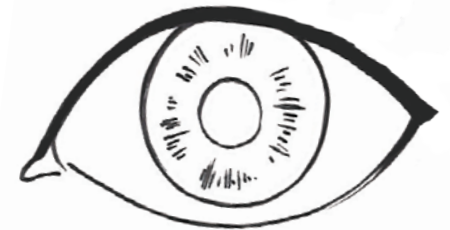

F

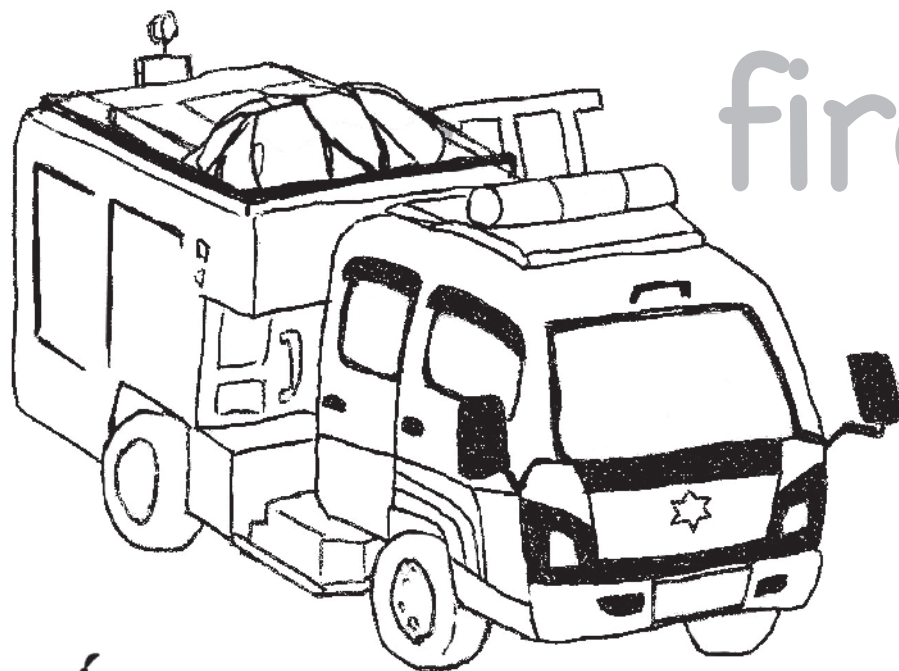

fire engine

f



firefly



fishing

G

ghost

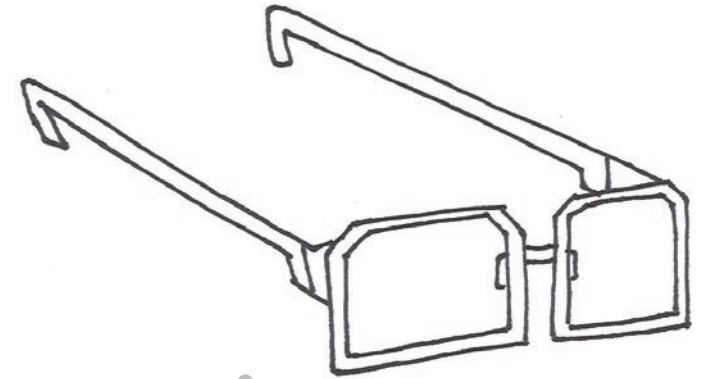

glasses

g



giraffe



grasshopper

H

helicopter

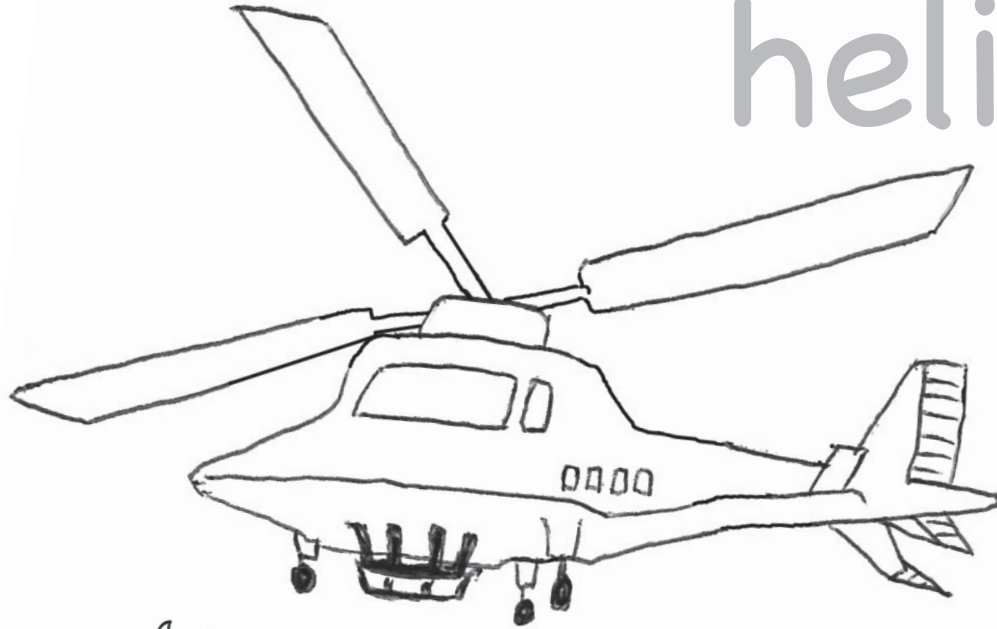

h

horse

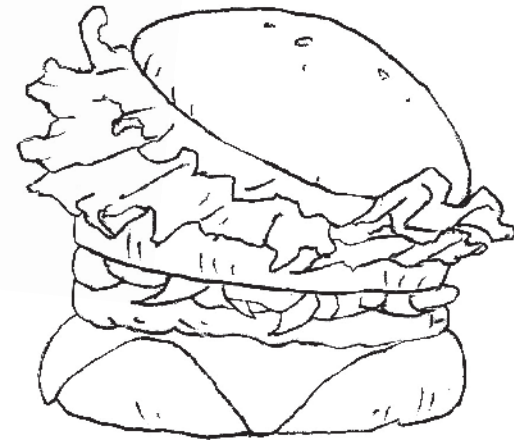
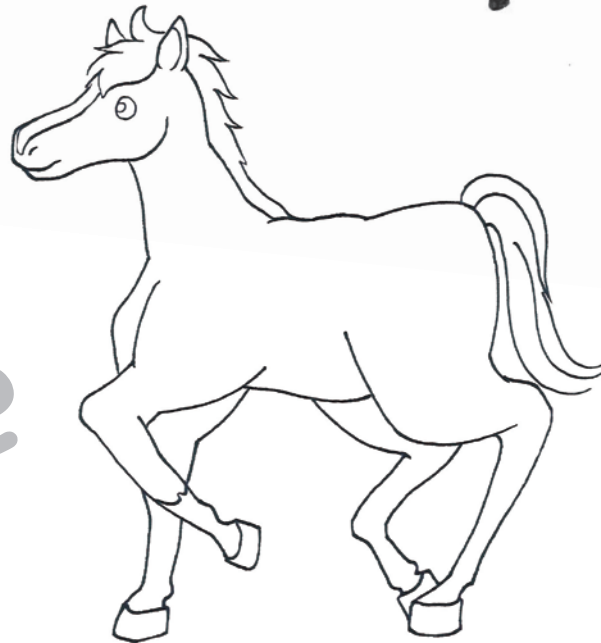

hamburger



I

i



ice cream

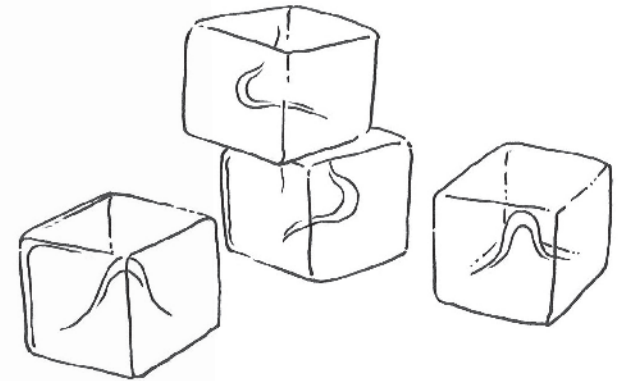

ice



interview

J

j

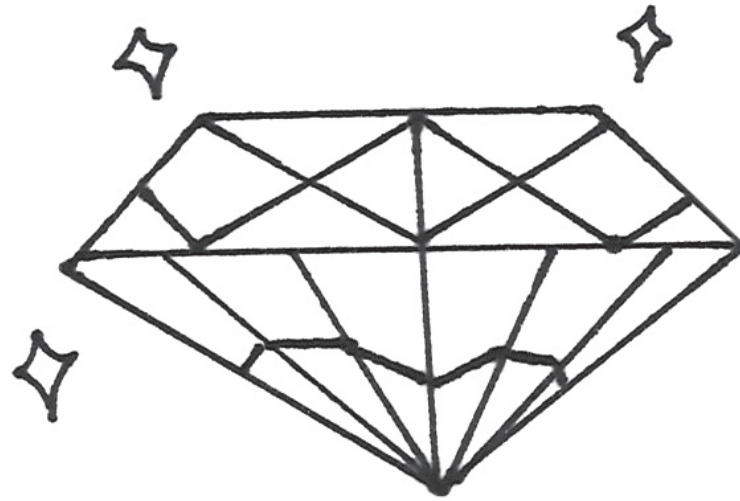

jewelry

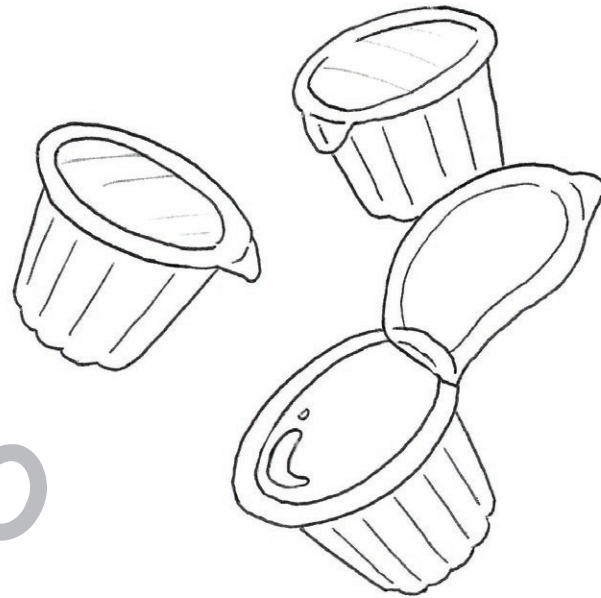

jello



juice

K

K

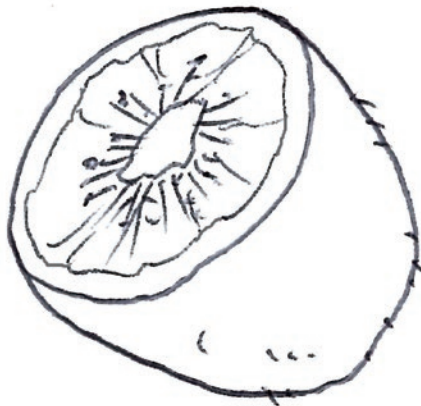

kiwi



king

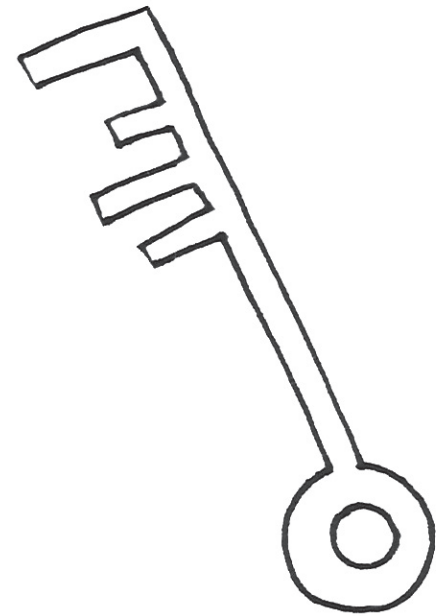

key

L

lion

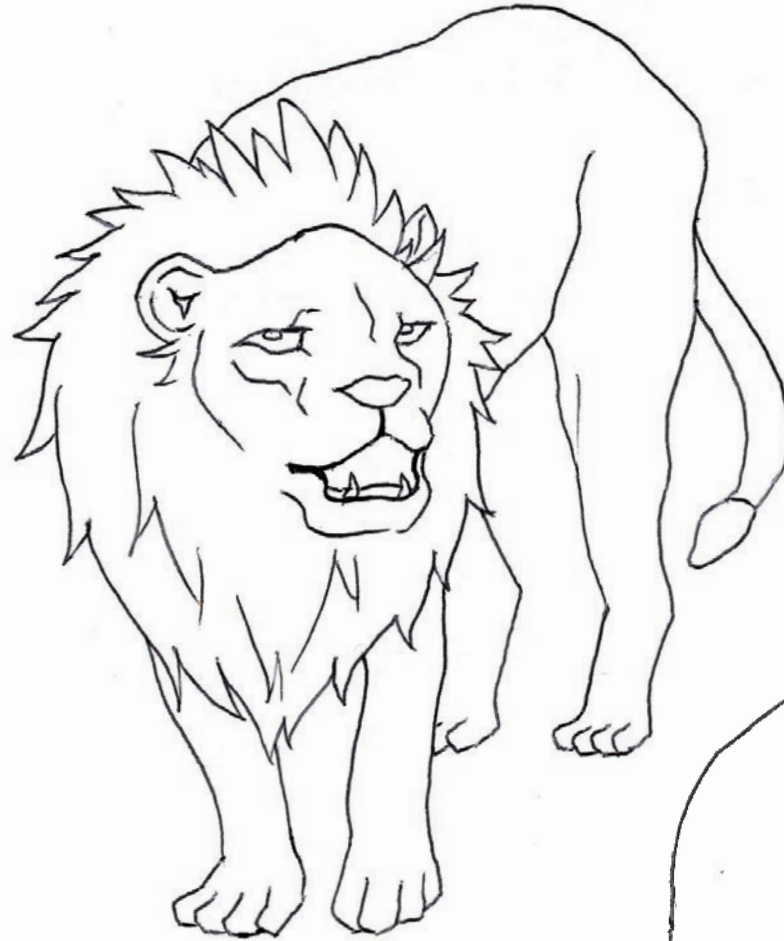

l



ladybug

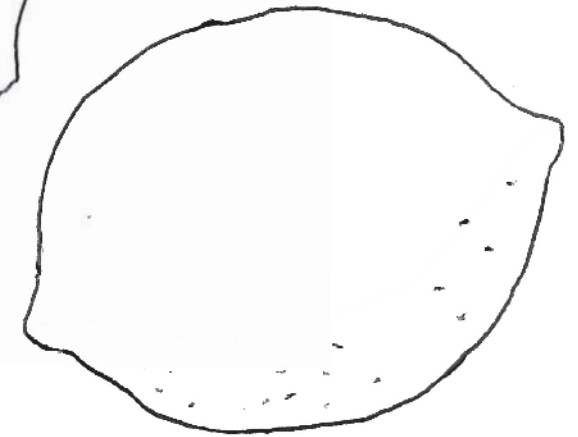

lemon

M

m



monkey

mantis

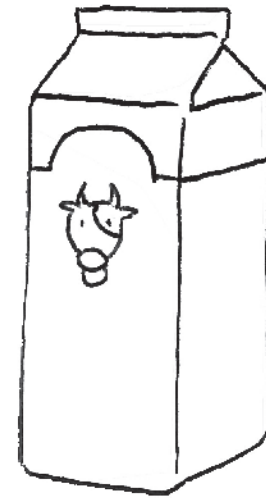

milk



mouse

N

night

newspaper

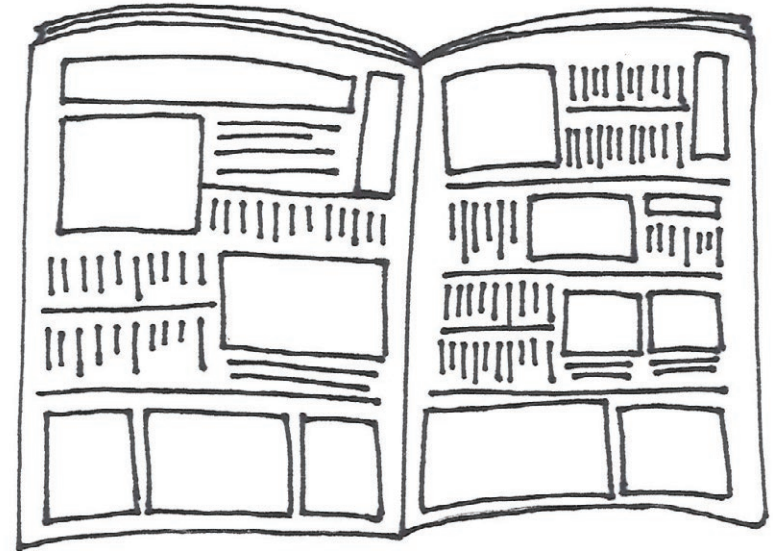

n

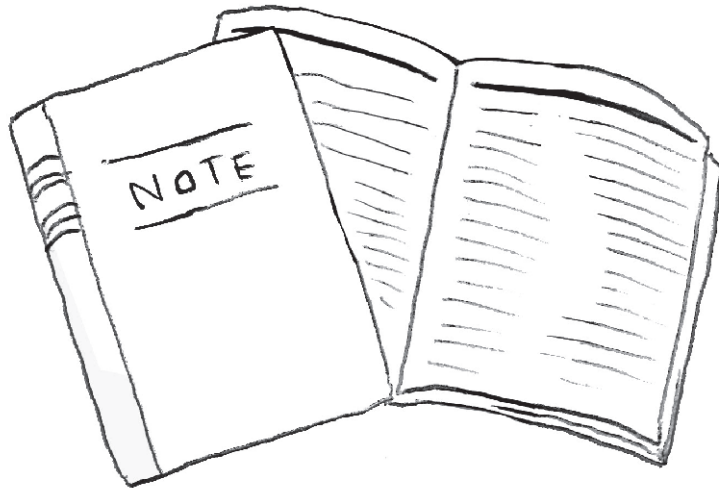

notebook

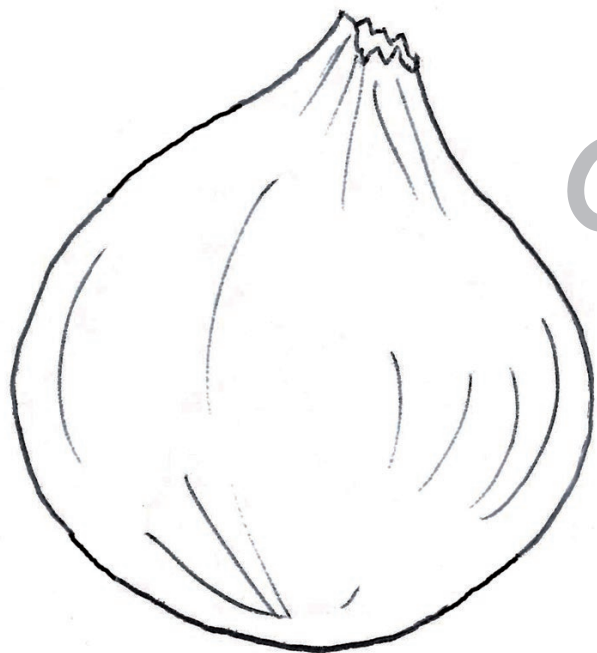
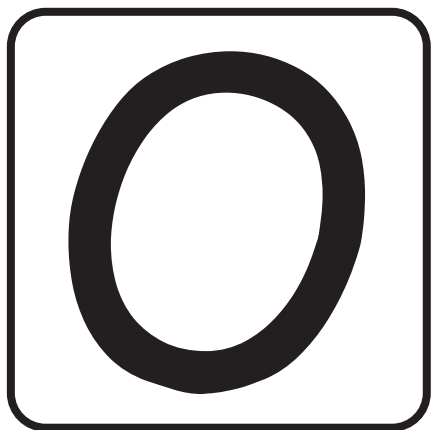

onion

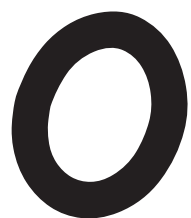

orange

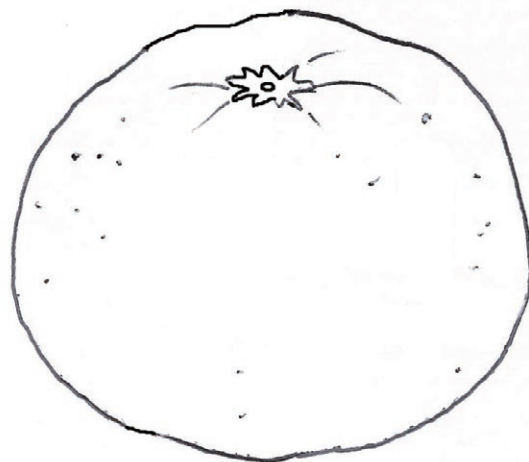

octopus



P

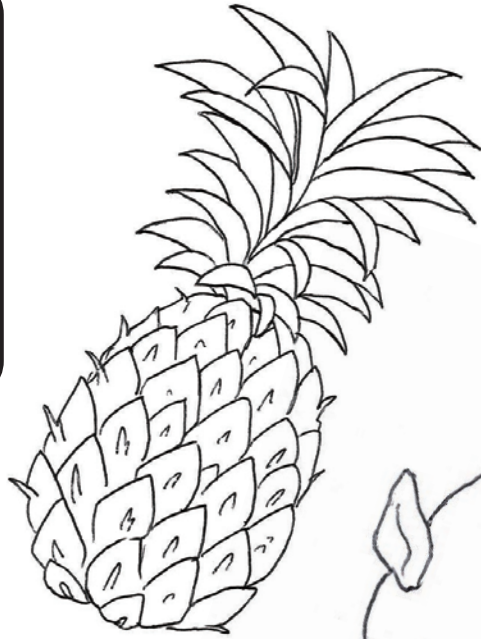

pineapple

panda



p

peach

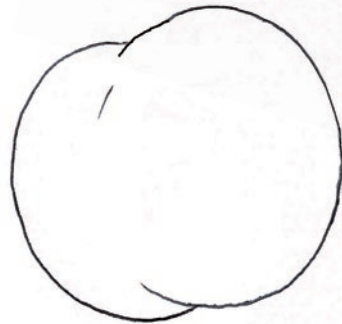

princess





quarter

q



question

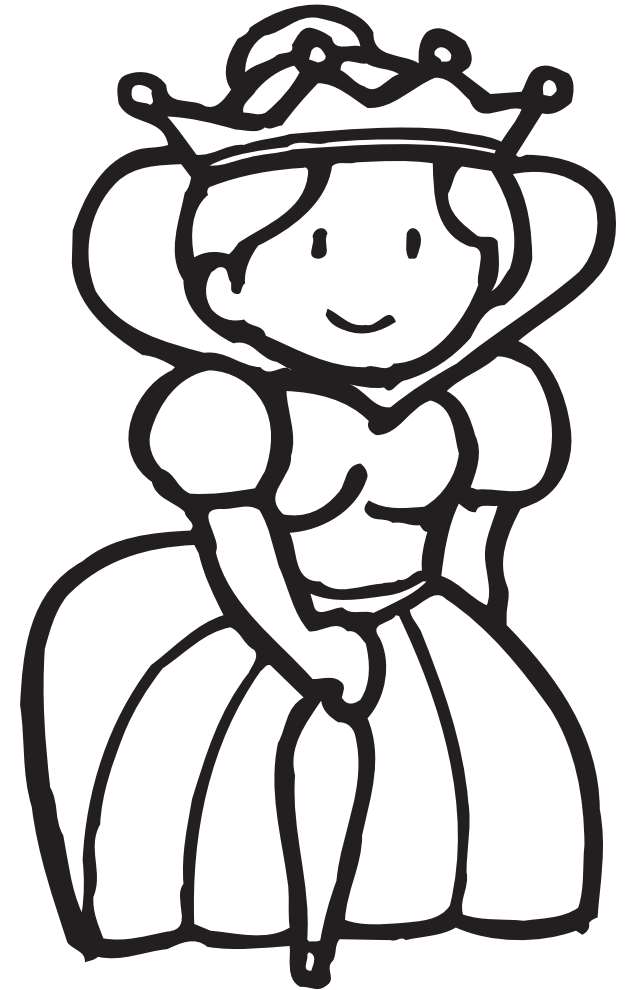

queen

R

rose



r

rain

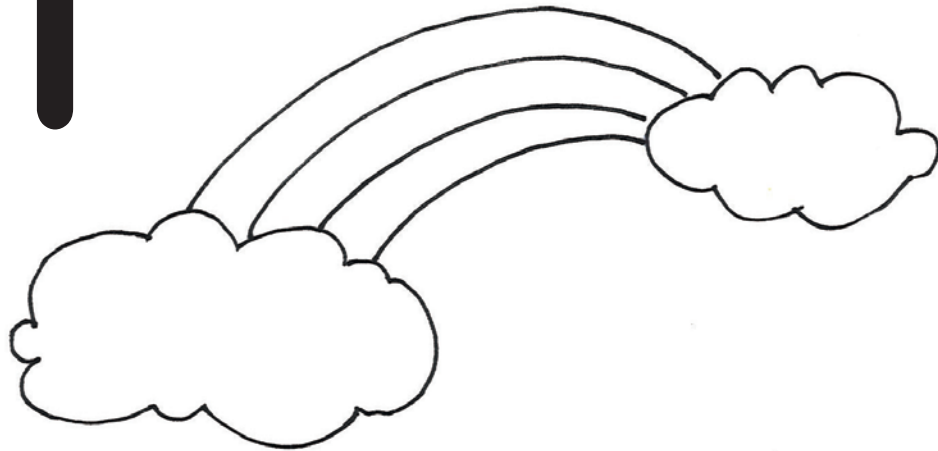

rainbow



S

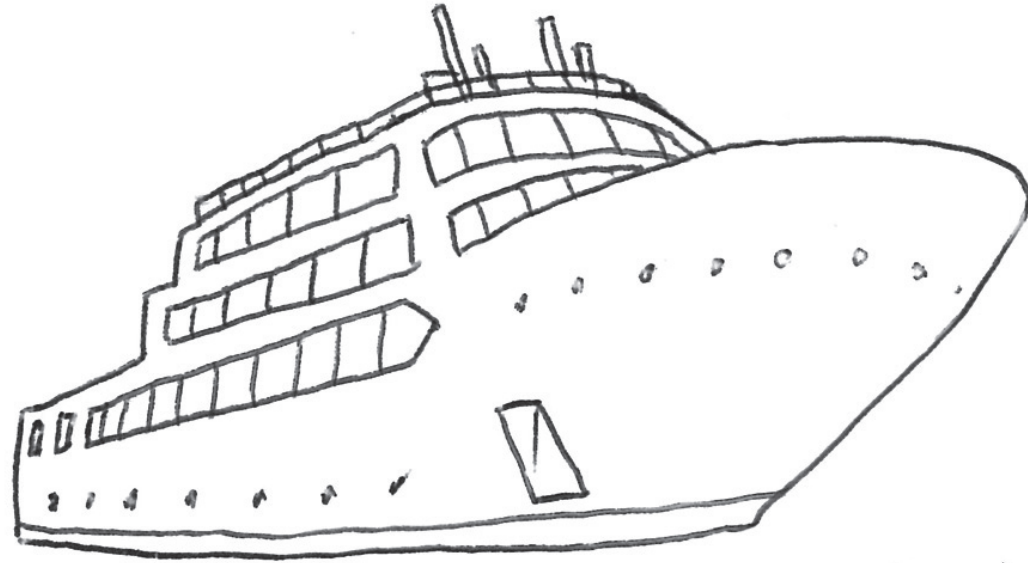

ship

s

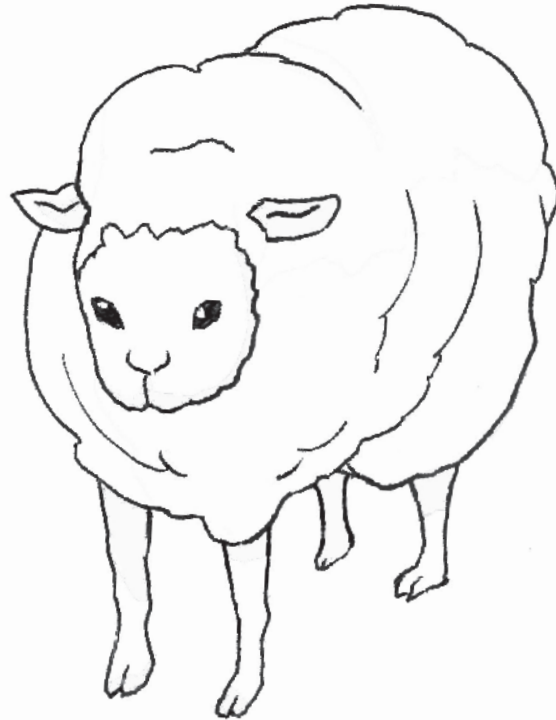

sheep



strawberry

T

+

tea

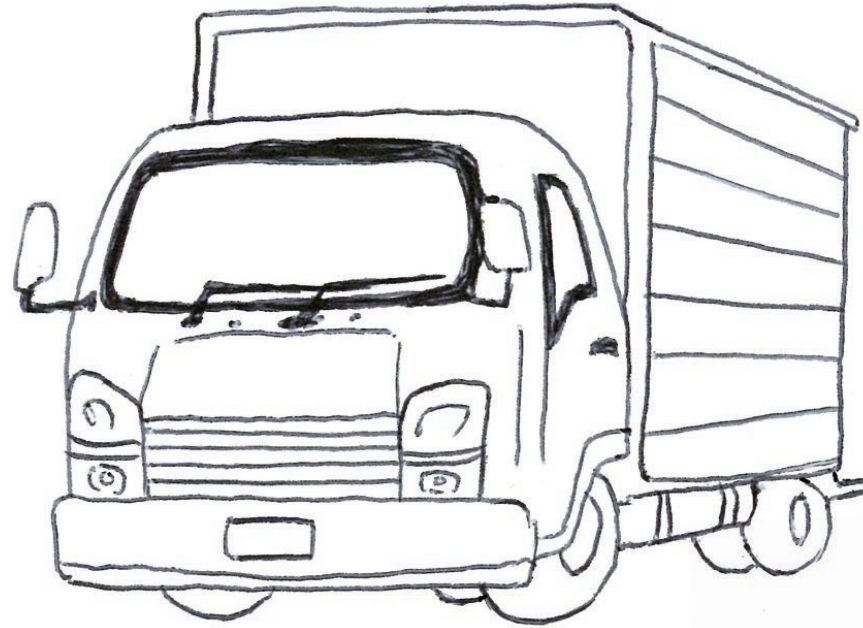

truck



tiger



U

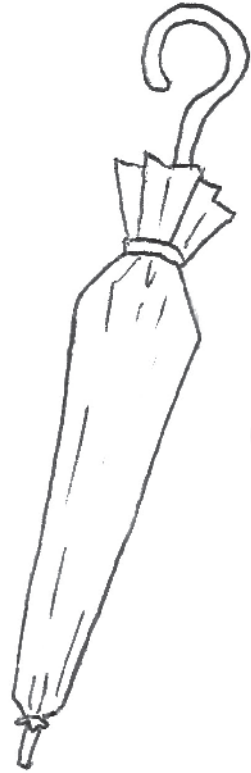

umbrella

u

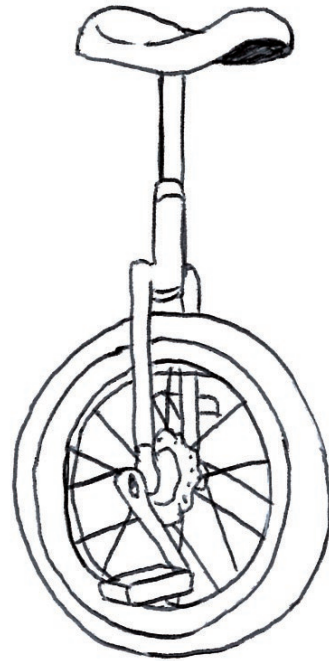

unicycle

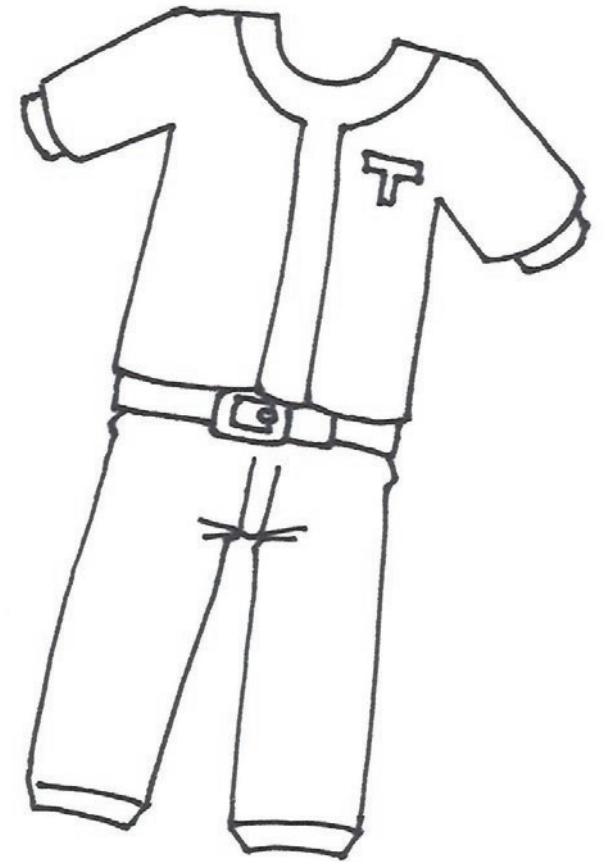

uniform



volleyball



village

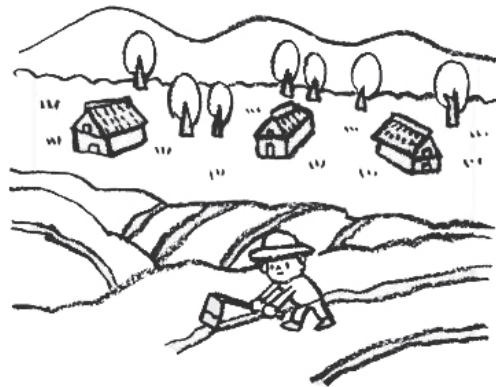

vegetable

W



watermelon

w



watch

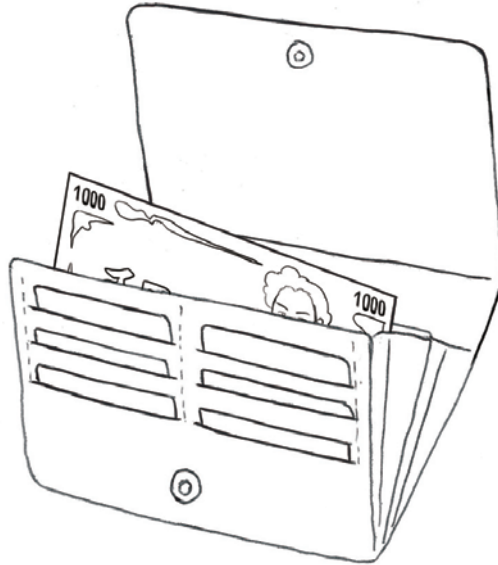

wallet

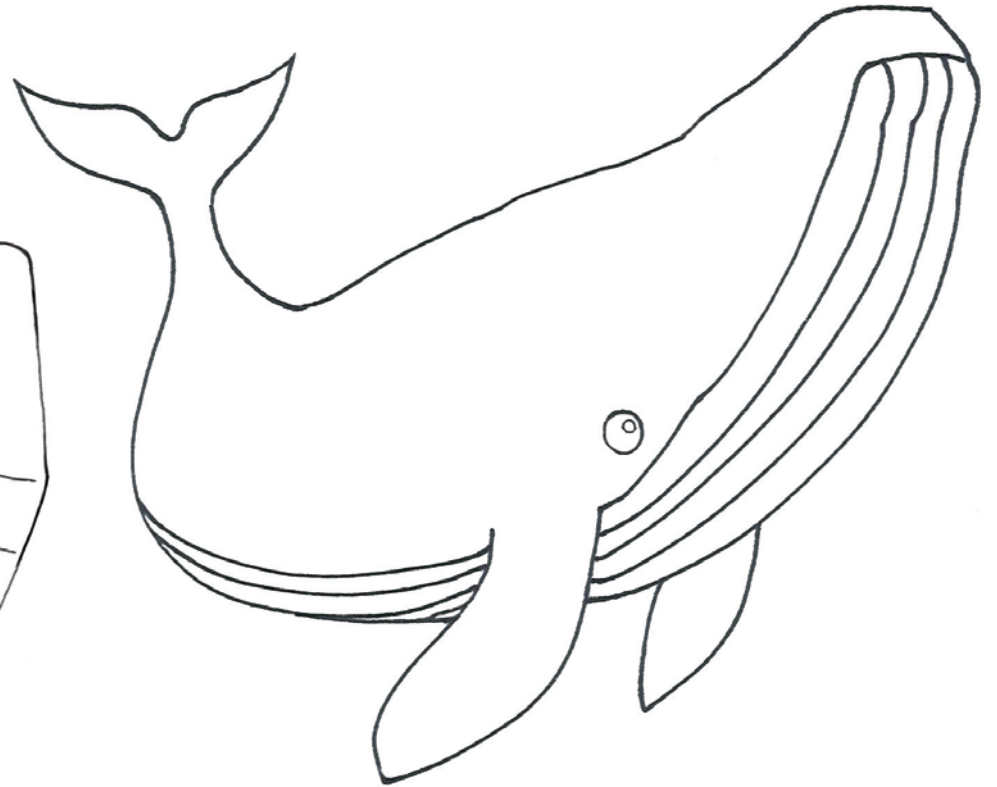

whale

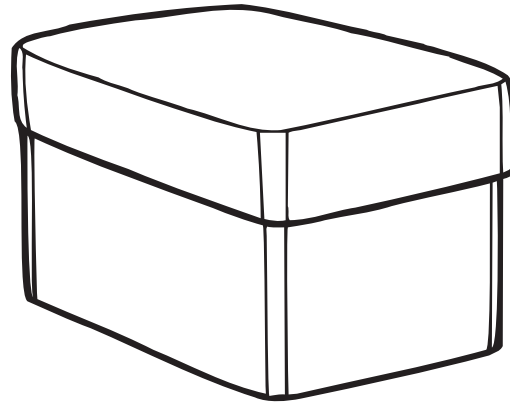
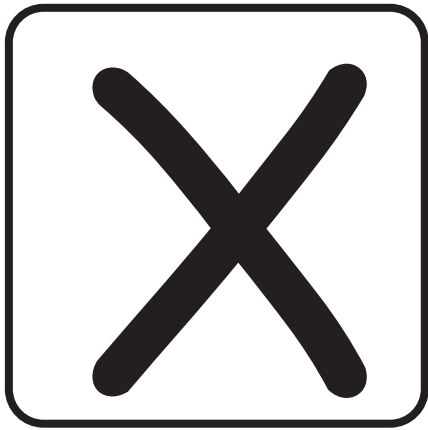

box



fox

X



taxi





yard

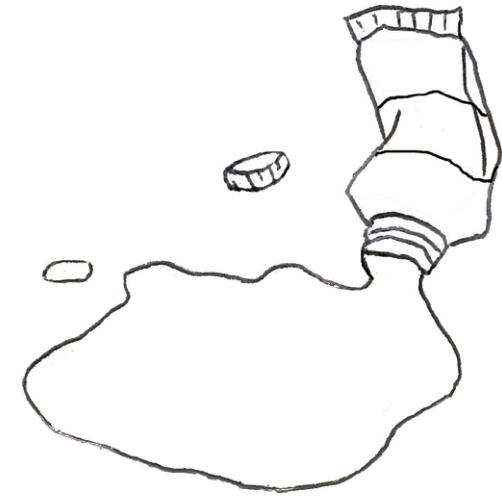

yellow

y



yesterday

Z

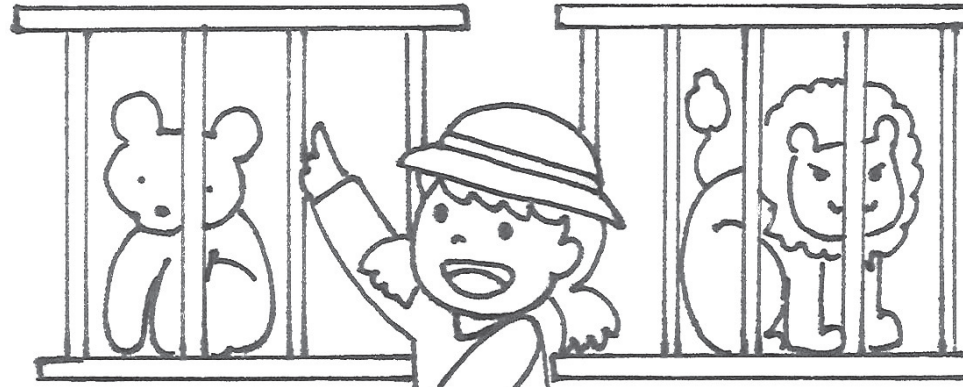

zoo

zebra

Z

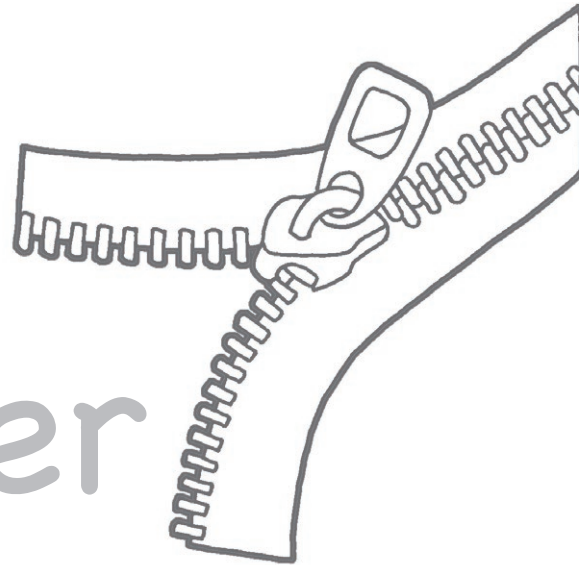

zipper

